

6-Slot RL-120 Directional Coupler

DC6A120

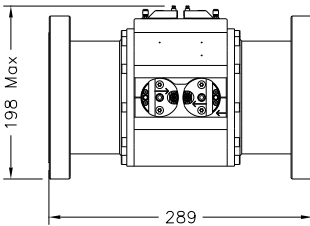
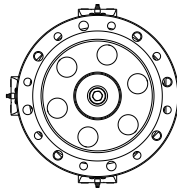
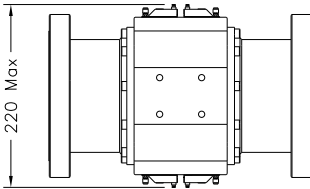
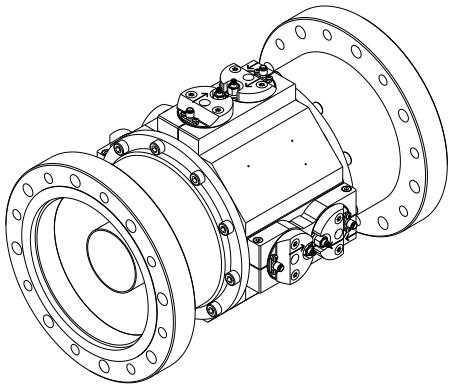

FEATURES

- 6-Slot (Up to 6 Probes)
- *Accuprobe*: Equalized Response Probes
- SMA or N Female Probe Connectors
- Interchangeable Probes
- Interchangeable Connector System

OPTIONS

- SMA or N Female RF Detectors

SPECIFICATIONS

Code / Revision	C-DC6A120 / A
Frequency Range	100-800 MHz
Max RMS Output Power	130.0 kW @ 100 MHz 90.0 kW @ 200 MHz 65.0 kW @ 400 MHz 45.0 kW @ 800 MHz
No. of Probes	Up to 6
Coupling Range	-57 to -77 dB
Coupling Flatness ⁽¹⁾	±0.15 dB
Return Loss / VSWR	> 36 dB / < 1.03
Directivity	> 32 dB
Max Operating Temperature (Body)	65°C (149°F)
Environmental Conditions	-5 to +55°C (+23 to +131°F), IP60
Dimensions / Weight ⁽²⁾	289x198x220 mm / 7.3 kg (16.1 lb.)
Connectors ⁽³⁾	2x 150 mm Series Input; Output D-PC150V 6+1/8" EIA FastLine Flange
Options ⁽³⁾	O-YRF.01 N Accuprobe RF Detector O-YRF.02 SMA Accuprobe RF Detector

⁽¹⁾ Within *Accuprobe* range ⁽²⁾ Default configuration ⁽³⁾ Other Connectors/Options available